

# INSTALLATION GUIDE

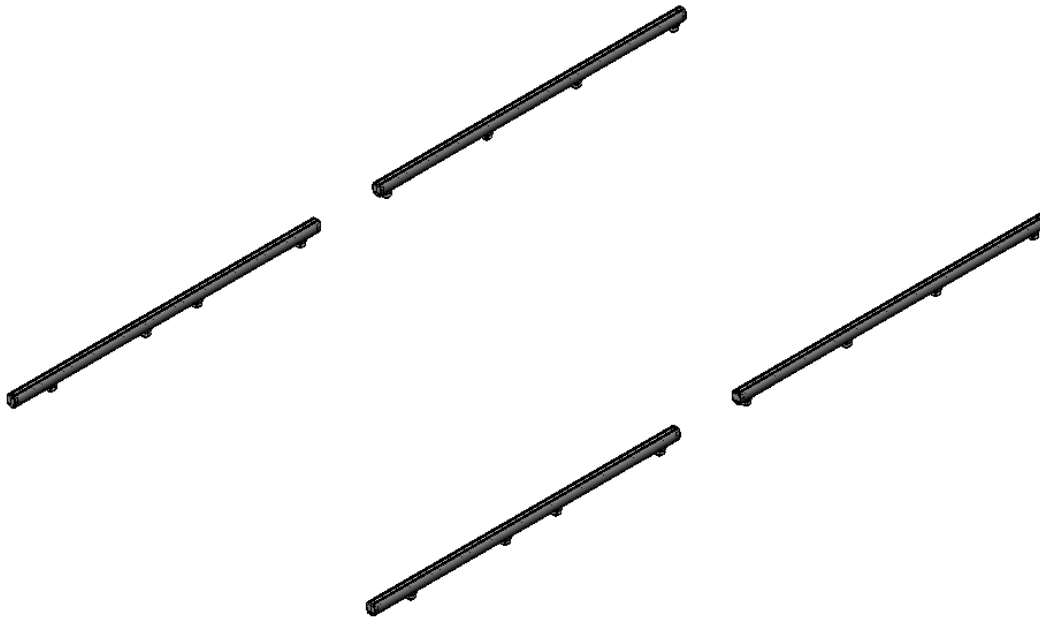

## 18-U0018 Mounting Tracks

Mercedes Sprinter ( Standard & High Roof )



# QUICK START GUIDE

## PHASE 1 - ASSEMBLY

- 1.1.1 SETUP ( VERIFY ALL PARTS ARE PRESENT )..... 2 TO 3

## PHASE 2 - INSTALLATION

- 2.1.1 INSTALLATION ( INSTALL THE MOUNTING TRACK WITH PADS ON THE ROOF )..... 4

## REQUIRED ITEMS

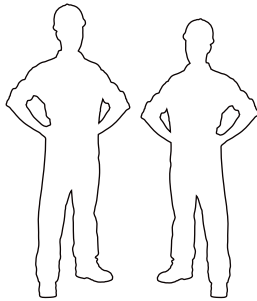

**2  
PERSONS**

- Cordless Impact
- Tape Measure
- Ladder
- 1/2" Socket

## PHASE 1 – ASSEMBLY

### 1.1 SETUP

1.1.1 Verify all parts are present.

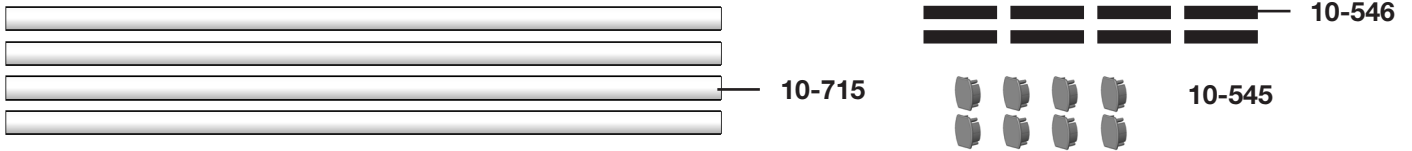

### WITH RANGER DESIGN TRACKS

Item No.	Description	Qty.
10-545	Plastic Plug	8
10-546x6	Track Plug	8
10-715	Mounting Track 50"	4
96-0018	Installation Fastener Bag	1

1.1.3 Identify the **Assembly** and **Installation** fastener bags.

**Installation Fastener Bag**

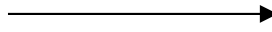

**Fastener Assembly**

12x  # 90-491 Carriage Bolt  
5/16"-18 x 1"  
SS304

16x  # 90-495 Carriage Bolt  
5/16"-18 x 1-1/4"  
SS304

16x  # 94-105 Hex Nut  
5/16"-18  
SS316wax

16x  # 98-109 Flat Washer  
SAE 3/8"  
SS304

16x  # 98-123 Lock Washer  
5/16"  
SS304

16x  # 98-149 Spacer  
0.290" ID x 1.375" OD x 0.125" L  
NEOPRENE

16x  # 98-169 Flat Washer  
External Shake Proof Washer  
ZINC

**12x w/ RANGER DESIGN TRACK**

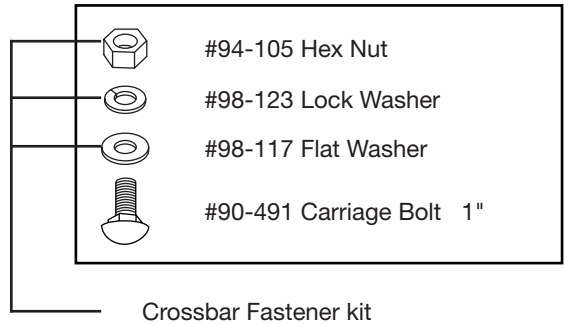

**16x w/ RANGER DESIGN TRACK**

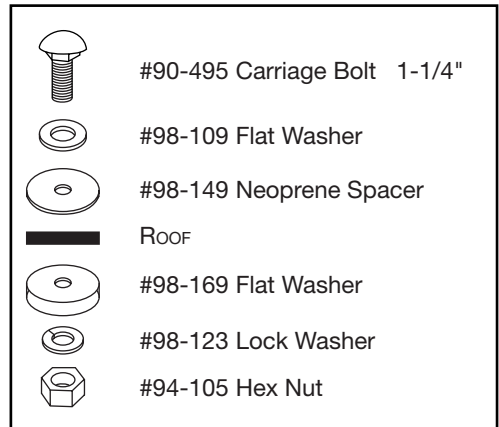

# PHASE 2 – INSTALLATION

## 2.1 MOUNTING TRACKS INSTALLATION

2.1.1 Install the hardware onto the mounting tracks.

### WITH RANGER DESIGN TRACKS

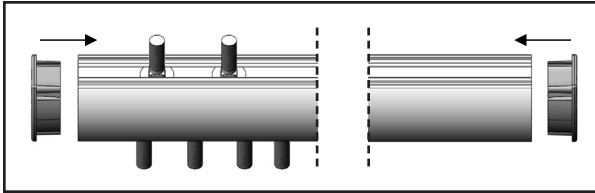

#### FASTENERS USED

8x (2 PER MOUNTING TRACK) TOP



#90-491 Carriage Bolt 5/16" x 1"

16x (4 PER MOUNTING TRACK) BOTTOM



#90-495 Carriage Bolt 5/16" x 1-1/4"

- 2.1.2
- Align the bottom bolts to the roof holes.
  - Attach the plug extrusions on both ends of the mounting tracks.
  - Install the mounting tracks onto the roof.
  - Apply a bead of silicone around each hole,** then fasten the tracks to the roof.

### WITH RANGER DESIGN TRACKS

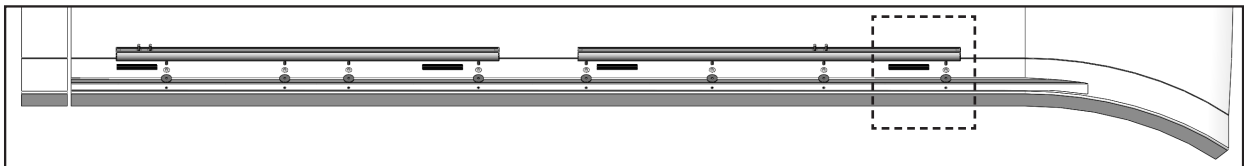

**IMPORTANT:** Apply a bead of silicone around each hole.

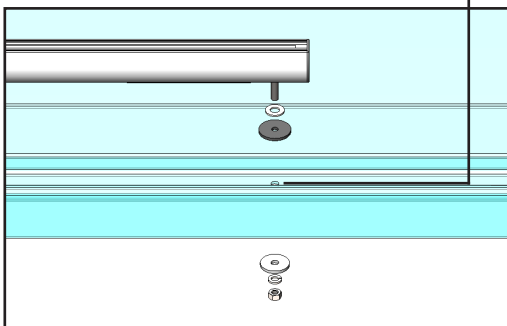

16x



#90-495 Carriage Bolt 1-1/4"



#98-109 Flat Washer



#98-149 Neoprene Spacer



#98-169 Flat Washer



#98-123 Lock Washer



#94-105 Hex Nut

#### TOOLS

- Cordless Impact
- 1/2" Socket

INSIDE

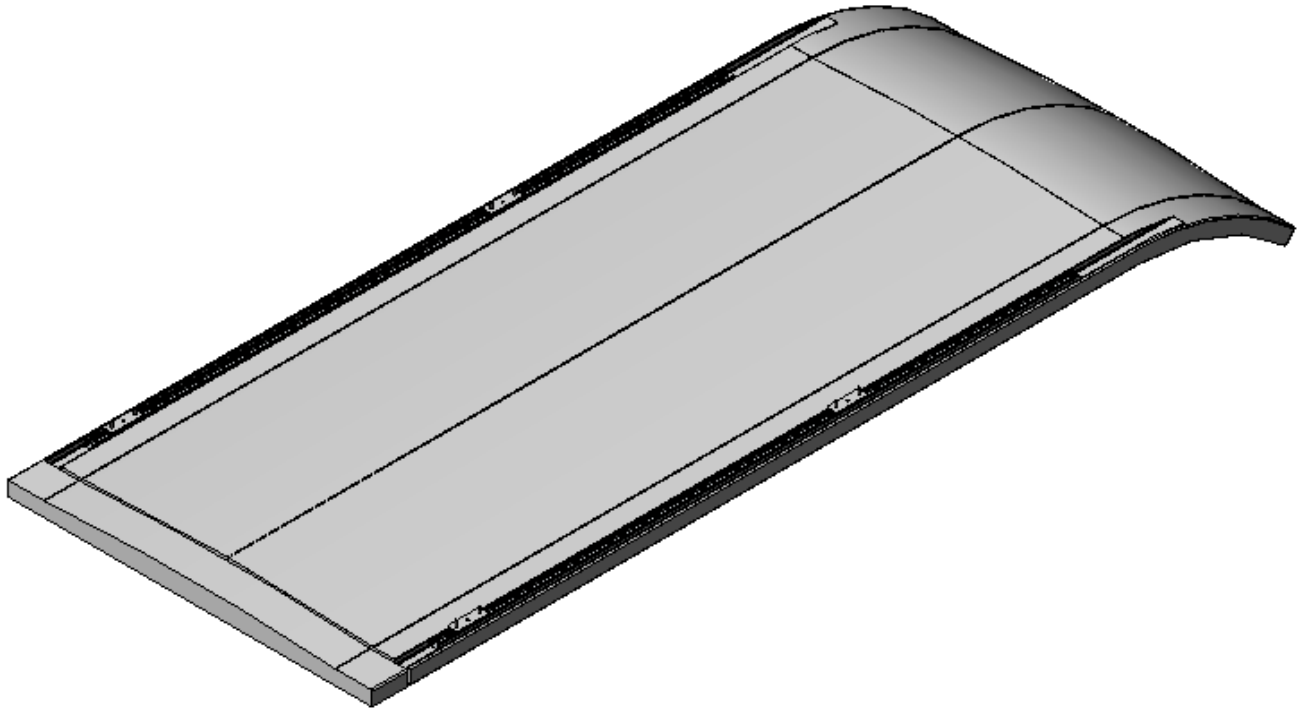

**“Congratulations, you have successfully installed your  
Mounting Tracks**

**Thank you for doing business with us.”**

For any feedback or suggestions you might have, please contact: [cs@rangerdesign.com](mailto:cs@rangerdesign.com)

